

31 584 SD1 K800 CHIUVEȚĂ DIN OȚEL INOXIDABIL

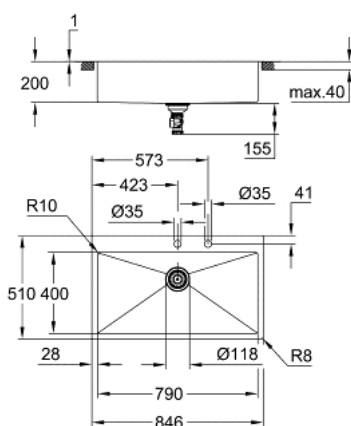

DESCRIEREA PRODUSULUI

- Colour: oțel inoxidabil
- model: K800 90-S 84.6/51 1.0
- mounting type: top mount or flush mount
- material: oțel inoxidabil AISI 304 (V2A)
- grosimea materialului: 1 mm
- finisaj GROHE LongLife
- suprafață: material satinat
- GROHE Whisper
- adâncimea min. a blatului: 900 mm
- dimensions: 846 x 510 mm
- 1 cuvă: 790 x 400 x 200 mm
- outer radius: R3, inner bowl radius: R10
- GROHE FastFixation sistem de instalare rapida
- cut-out (top mount): 831 x 495 mm (R3)
- cut-out (flush mount): 831 x 495 mm (R3) (top step outer size: -847 x 511 -R8 deep -3.5 mm)
- waste: Ø 3.5"/90 mm waste strainer with automatic waste fitting
- accesoriile incluse: mecanism automat de scurgere, kit de scurgere, sită scurgere, kit de montare
- optional push to open excenter (40 986 SD0)
- amount of fasteners included (top mount): 10

31 584 SD1 K800 CHIUVEȚĂ DIN OȚEL INOXIDABIL

PIESE DE SCHIMB , octombrie 2019 – now

1: Fișa de conectare (Spare part-nr. 42588SD0)

2: legătură pivotantă (Spare part-nr. 42586SD0)

3: Cover element (Spare part-nr. 42590SD0)

